

Waterproof (WRP2) ReSet Call Point, (WSS3) StopperPush & StopperLatch Series 01, 02, 05 & 11

New Waterproof (WRP2) ReSet is a unique all weather surface-mounted manual call point that mimics the feel of breaking glass whilst offering the user the benefits and safety advantages of a glass-free resettable operating element. Specially designed for use with harsh environments, the Waterproof ReSet is ideal for industries that are sensitive to broken glass along with outdoor applications such as: oil rigs, ships, factories and wash-down areas. Once activated a warning flag drops into view, easily identifying that the call point that has been operated. Also available is the New Waterproof (WSS3) StopperLatch format: once activated, a key can be used to quickly and conveniently reset the unit, and the Waterproof (WSS3) StopperPush button is also available where a momentary push-and-release function is required.

WRP2 ReSet Call Point

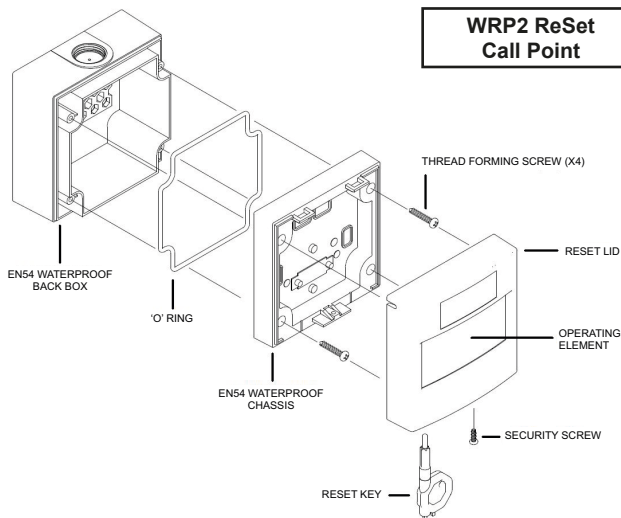

WSS3 StopperLatch & StopperPush

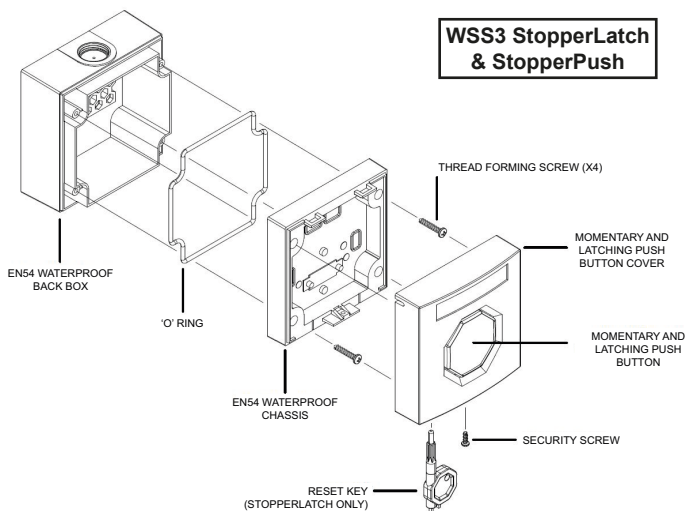

Connection Options for Waterproof (WRP2) ReSet Call Point 05

Waterproof (WRP2) ReSet Series 05 Configuration

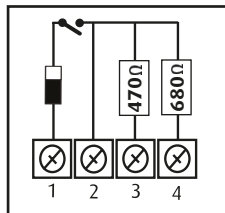

Option 1 terminals 1 & 2

Normally open switch closing on alarm

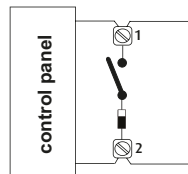

Option 2 terminals 1 & 3

Normally open switch closing on alarm with a 470 ohm resistor fitted in series with the switch

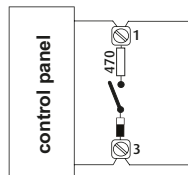

Option 3 terminals 1 & 4

Normally open switch closing on alarm with a 680 ohm resistor fitted in series with the switch

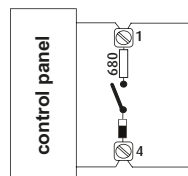

Technical Data for Waterproof (WRP2) ReSet Call Point, (WSS3) StopperLatch and (WSS3) StopperPush Series 01, 02, 05 & 11

Mounting Method

1. The New Waterproof (WRP2) ReSet call point, StopperLatch & StopperPush is supplied complete with their own surface mounting IP67 back box.
2. Ensure the conduit or cabling lines up with the conduit entries located at both the top and bottom of the reversible back box. To maintain IP rating it is recommended that entry to the IP67 back box is done from below, using the one or two 20mm conduit entry holes (knockouts) as required. (Remove the appropriate conduit threaded insert as appropriate.)
3. With back box in place, mark the position of the 3 fixing holes. Drill the holes and affix using the 3 screws & rawl plugs provided. Note: 3 screws are used to avoid distortion when mounting on uneven surfaces.
4. Taking the terminal chassis, ensure that the shaped "O-Ring" is evenly positioned inside the surrounding channel.
5. When the wiring connections are complete, orient the terminal chassis onto the back box ensuring that the two hinge tabs are at the top and central screw-hole tab at the bottom. Firmly secure the terminal chassis onto the back box using the 4 screws provided. Note: For multiple call points in a system, it is permissible to loop in/out using the same two terminals.
6. Carefully attach the ReSet / StopperLatch / StopperPush front cover to the top of the terminal chassis using the top hinges, and secure the retaining screw at the base using the allen key provided.
7. Maintenance (ReSet / StopperLatch): there is no need to replace parts, simply activate to test and reset using the reset key provided. Note: the use of lubricants/cleaning solvents should be avoided.

Dimensions

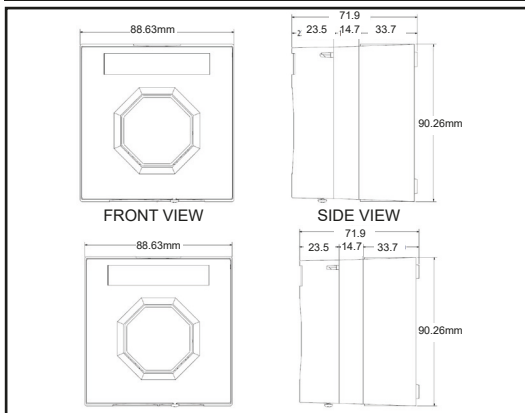

Specifications

Current Rating (Series 01, 02 & 11)	3 Amps 12 - 24V DC
Current Rating (Series 02 & 11 only)	6 Amps 125 - 250V AC
Housing/Mounting Box Material	Polycarbonate/Glass Reinforced Nylon
Electrical Contact Material	Silver plated brass
Operating Temperature	-20°C to +65°C
Installation Terminal Conductor Size	0.5mm to 2.5mm

(WRP2) ReSet, (WSS3) StopperLatch & StopperPush Series 01, 02, 05 & 11 Single & Double Pole Changeover

Waterproof (WRP2) Series 01

Denotes a Waterproof (WRP2) ReSet Call Point that will interface with most conventional fire alarm systems. It is fitted with two internal resistors: 470 and 680 ohm. These are easily accessed through the installer terminals as illustrated.

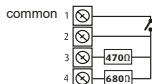

Waterproof (WRP2 & WSS3) Series 02

Denotes a Waterproof (WRP2) ReSet Call Point & (WSS3) StopperLatch / StopperPush that is fitted with a single pole changeover switch. Both the normally open and normally closed contacts are easily accessed through the installer terminals as illustrated.

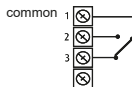

Waterproof (WRP2) Series 05

Denotes a Waterproof (WRP2) ReSet Call Point that will interface with most conventional fire alarm systems. It is fitted with two internal resistors: 470 and 680 ohm and a diode. These are easily accessed through the installer terminals as illustrated.

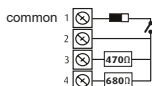

Waterproof (WRP2 & WSS3) Series 11

Denotes a Waterproof (WRP2) ReSet Call Point & (WSS3) StopperLatch/StopperPush that incorporates two independent single pole changeover switches. These provide double pole changeover contacts that are easily accessed through installer terminals as illustrated.

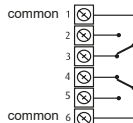

NB: Switch arrangements shown with Waterproof (WRP2) ReSet, (WSS3) StopperLatch & StopperPush in standby.

Waterproof (WRP2) ReSet Series 01



Safety Technology International

Taylor House, 34 Sherwood Road
Bromsgrove, Worcestershire, B60 3DR England
Tel: +44 (0) 1527 520 999 Fax: +44 (0) 1527 501 999
Email: info@sti-emea.com Web: www.sti-emea.com



14
DoP-0905-CPR-00439-Rev1019



EN54-11

Type A Outdoor manual Call Point
WRP2 Series 01 only